

KEH-Gait: Towards a Mobile Healthcare User Authentication System by Kinetic Energy Harvesting

Never Stand Still

Faculty of Engineering

Computer Science and Engineering

Weitao Xu^{2,3}, Guohao Lan^{1,3}, Qi Lin^{1,3}, Sara Khalifa³,
Neil Bergmann¹, Mahbub Hassan^{1,3}, and Wen Hu^{1,3}

¹University of New South Wales, Australia

²University of Queensland, Australia

³DATA61 CSIRO, Australia



NDSS'17
February 27th, 2017



PREVENTION



HEALTHY LIFESTYLE



DIAGNOSTICS



Privacy & User Authentication

- User Authentication:
 - Confirm the identity of the user.
- Sensitive data:
 - Medical records
 - Bank account
 - Personal location information
 - and so on ...



Gait Recognition using Wearable Sensors

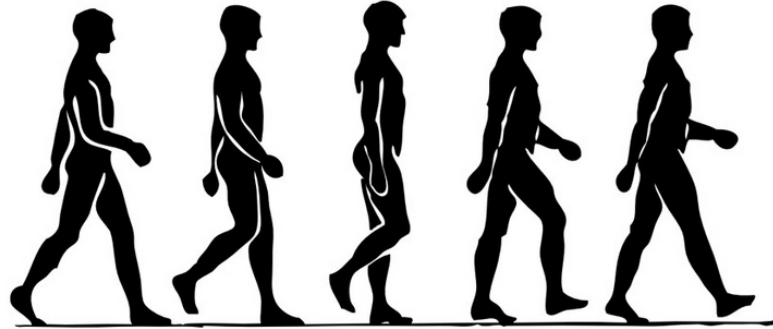

- Gait recognition:
 - Identifying an individual by his/her unique *walking pattern*.
- Using wearable sensors, *accelerometer*, to capture gait patterns.

Challenge: Power Constraint

- Limited Battery Life
 - Small form factor
 - High Energy Consumption:
 - Powering motion sensors
 - Powering micro-controller (MCU)
 - Powering wireless communication unit

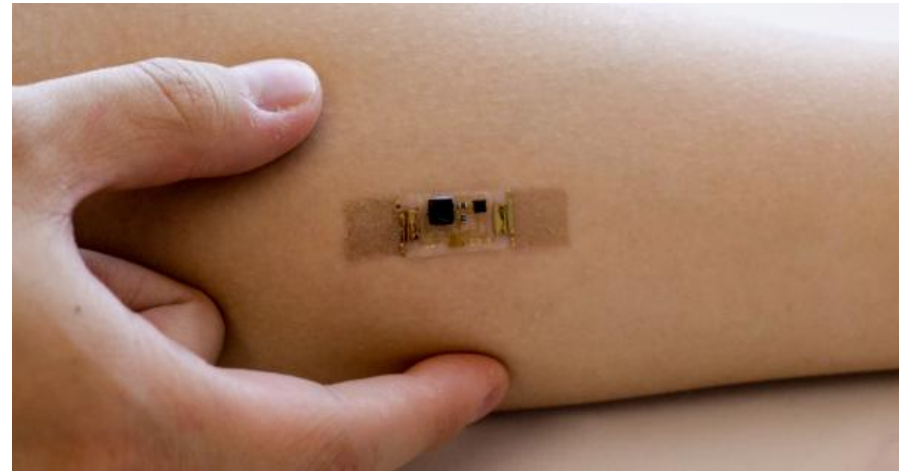
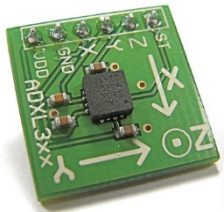

Kinetic Energy Harvesting (KEH)

- A new vision: Kinetic Energy Harvesting-powered wearable system.
 - Powering wearable devices using ambient kinetic motions.

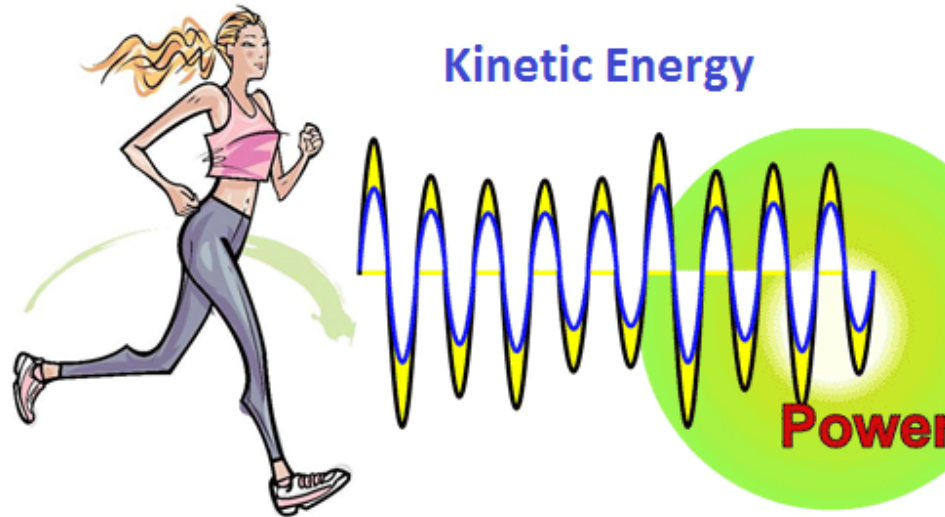





Kinetic Energy Harvesting (cont.)

- Practical products:

World's first wearable motion-charger



AMPY 	 Smartphone	 Smartwatch	 Fitness Tracker
WALK 10,000 steps daily average	3 HOURS	24 HOURS	72 HOURS
CYCLE 1 hour			
RUN 30 minutes			

Kinetic Energy Harvesting (cont.)

- Practical products:
Shoe sole based energy harvester

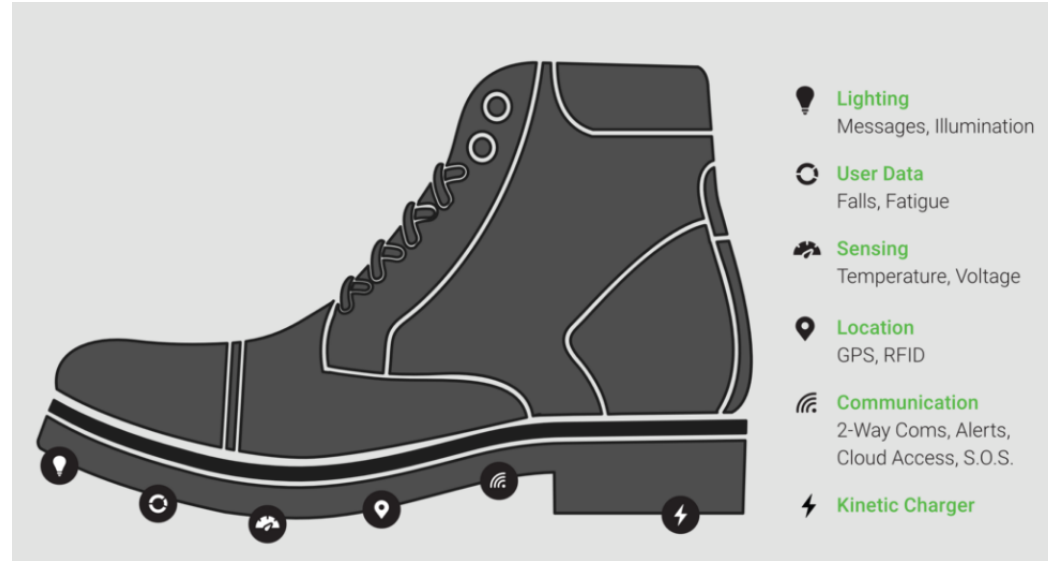

Motivations

- Accelerometer-based gait recognition is energy consuming
 - Continuous data sampling -> *High energy consumption*
 - Especially for resource-constrained wearable devices
- Kinetic energy harvesting is promising in powering wearable devices.
- **Our Idea:**
 - Gait recognition using the voltage signal generated by the KEH!
- **Intuition:**
 - If humans have unique walking patterns, then the corresponding patterns of the harvested power from KEH should also be unique.

System Overview

Traditional accelerometer-based gait recognition system:

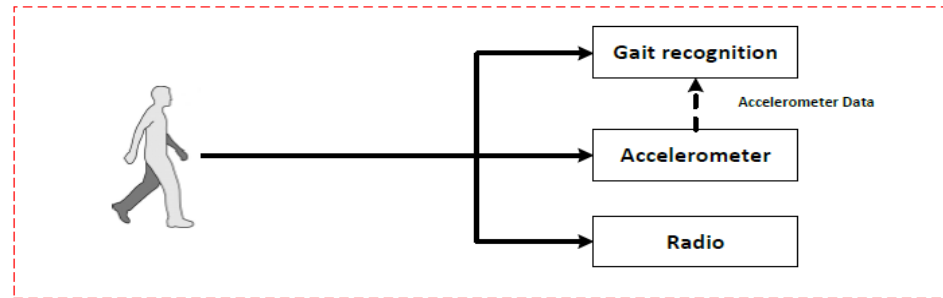

Proposed KEH-based gait recognition system (KEH-Gait):

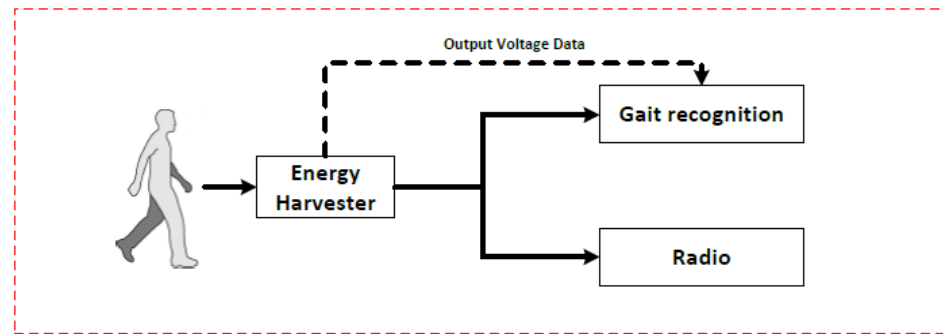

Prototypes Design

- Prototype One:
 - Piezoelectric Energy Harvester (PEH)

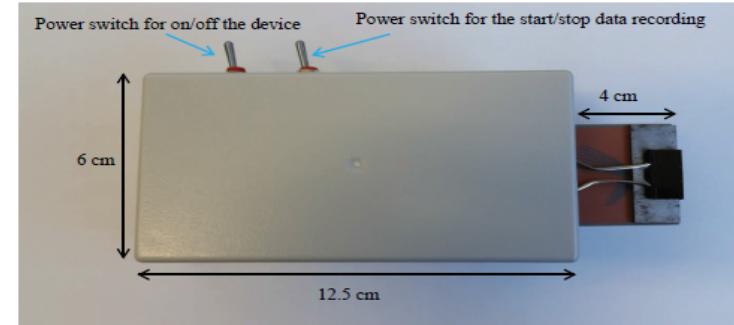
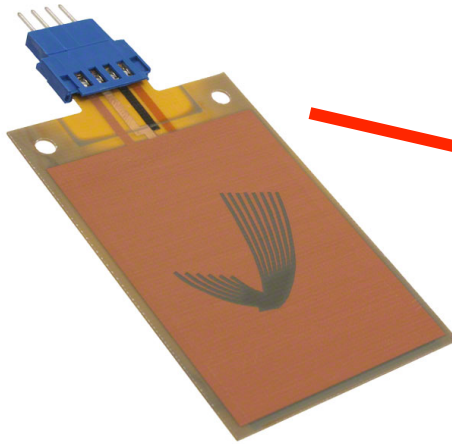

(a)

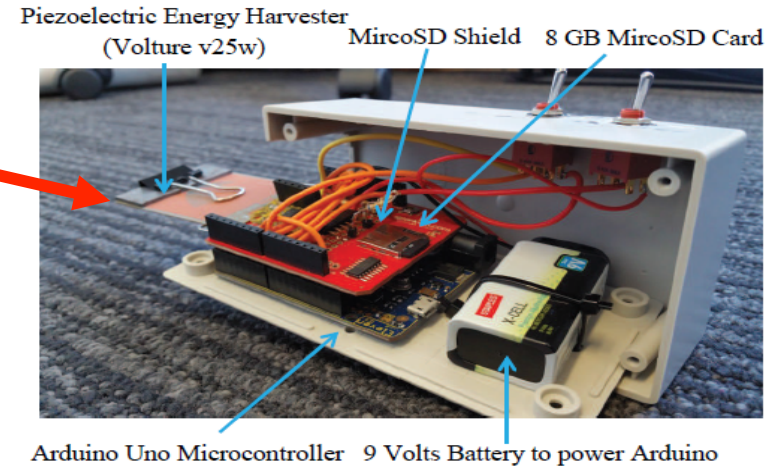

Prototype Design (cont.)

- Prototype Two:
 - Electromagnetic Energy Harvester (EEH)

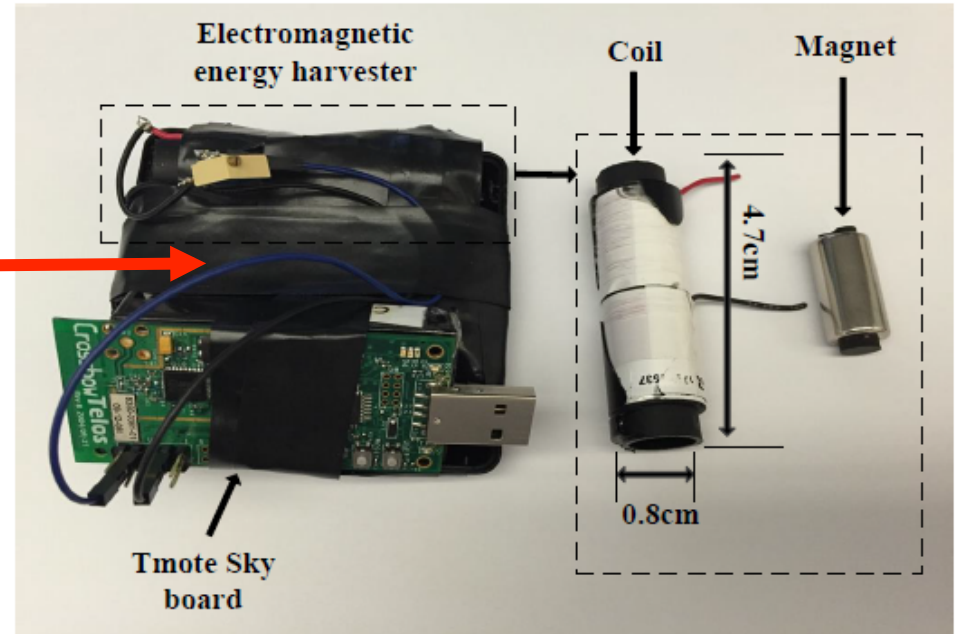
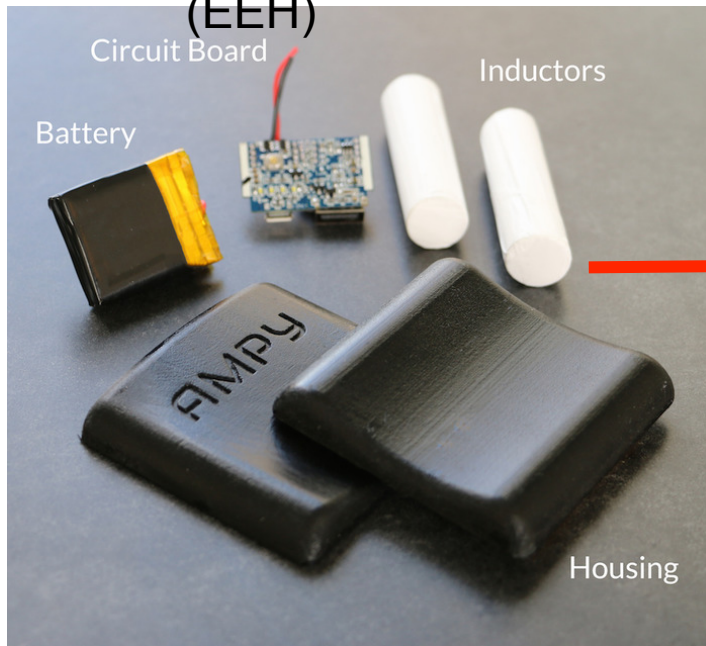

Data Collection

- Two Datasets
 - 20 subjects (14 males, 6 females)
 - Both Indoor and Outdoor
 - PEH-dataset
 - EEH-dataset



(a) Indoor experiment



(b) Outdoor experiment

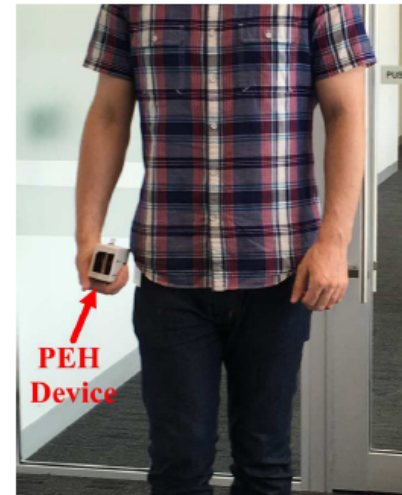

(c) Holding PEH device



(d) Holding EEH device

Signals

**Accelerometer
signal**

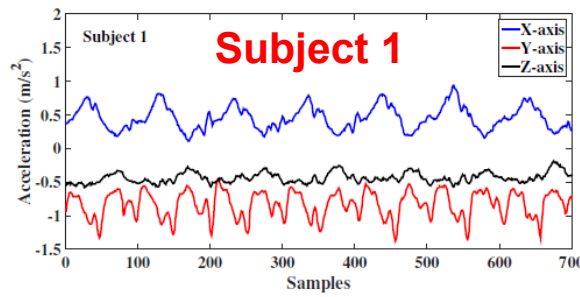

(a) Acceleration signal of subject 1

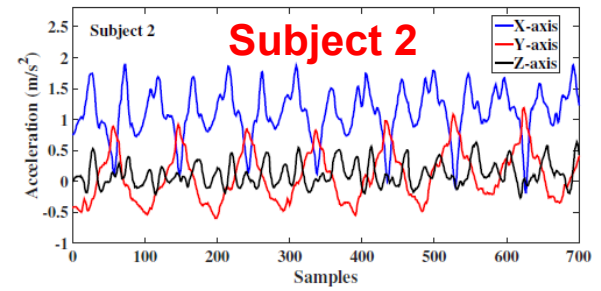

(b) Acceleration signal of subject 2

PEH signal

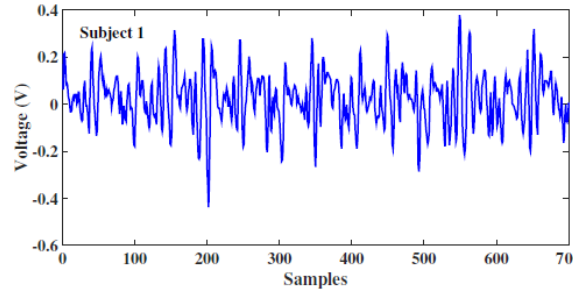

(c) Output voltage of subject 1 from a PEH device

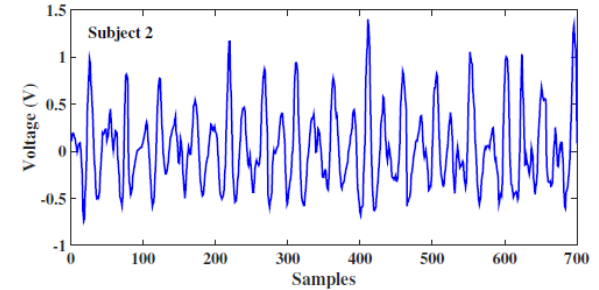

(d) Output voltage of subject 2 from a PEH device

EEH signal

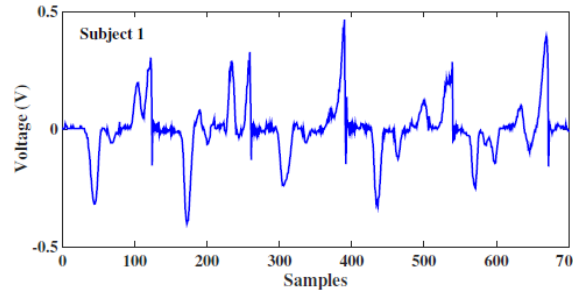

(e) Output voltage of subject 1 from an EEH device

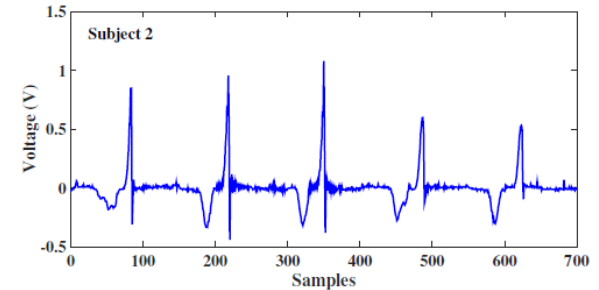

(f) Output voltage of subject 1 from an EEH device

Signal Processing

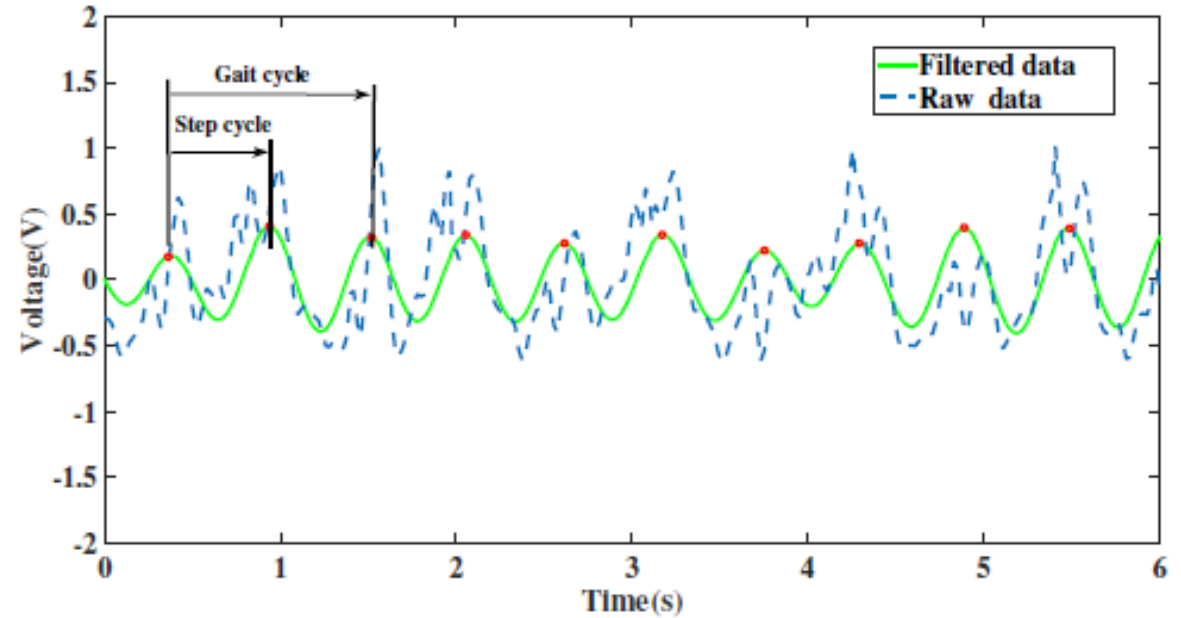
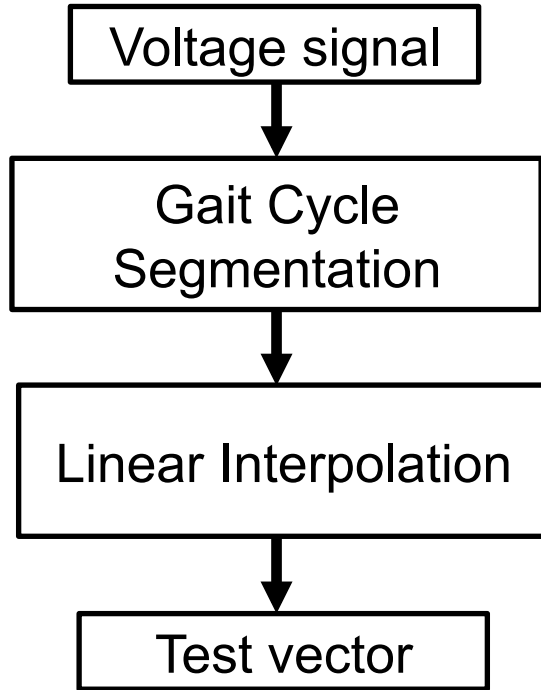

Multi-Step Sparse Representation Classification (MSSRC)

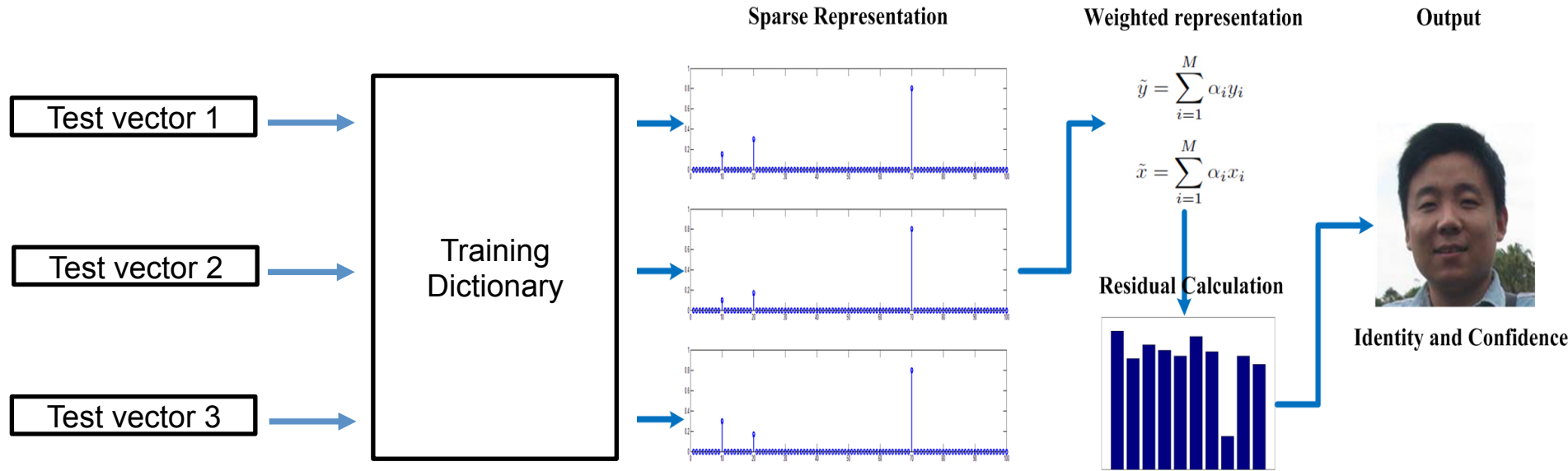

MVSRC exploits the sparsity of multiple steps and apply a weighted model to improve accuracy.

System evaluation

- Goals of evaluation:
 1. KEH-Gait v.s. Accelerometer-based system.
 2. Performance of two different energy harvesters:
 - Piezoelectric-based (PEH-based)
 - Electromagnetic-based (EEH-based)
 3. System robustness.
 - Against time variation.
 - Against different environments.

Evaluation results

- KEH-Gait v.s. Accelerometer-based system

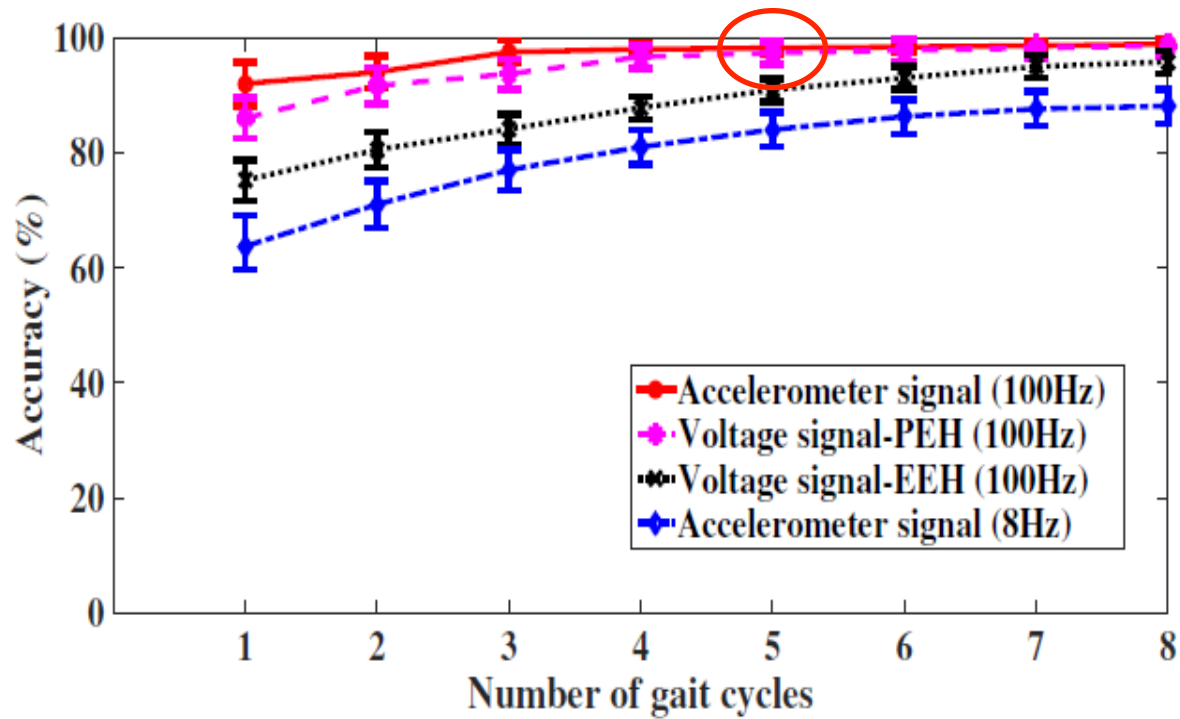

Evaluation results (cont.)

- Robustness to Gait variations:
 - Variations over time (one week)

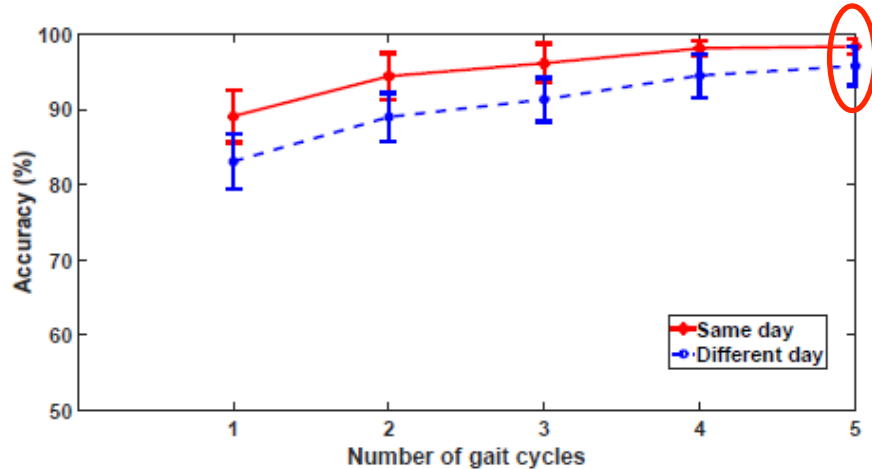

(a) PEH dataset

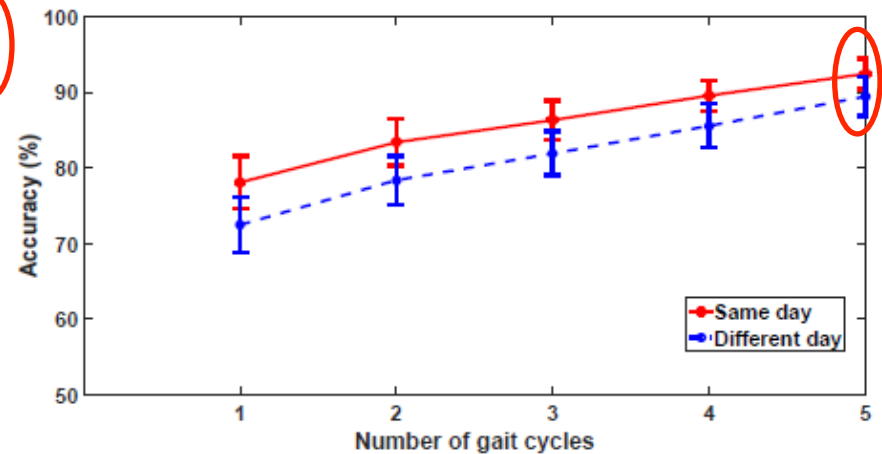

(b) EEH dataset

Accuracy of authentication in different days is approximately 5% lower than that of the same day authentication.

Evaluation results (cont.)

- Robustness to Gait variations:
 - Different environments:

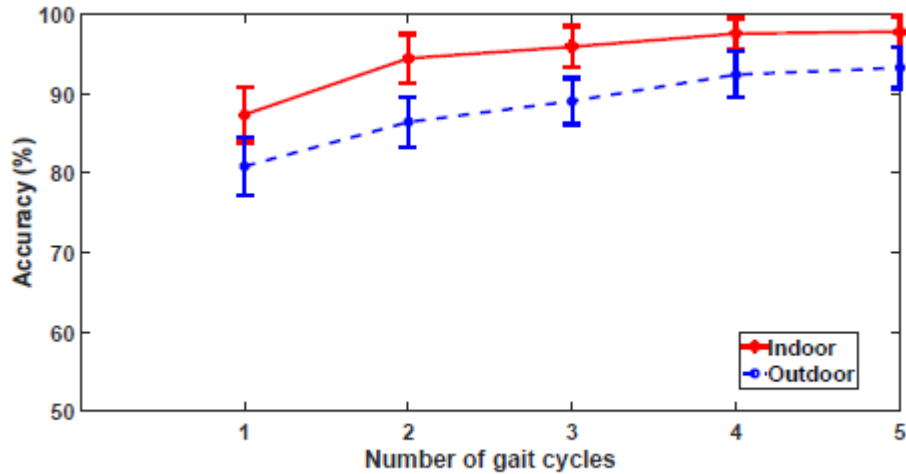

(c) PEH dataset

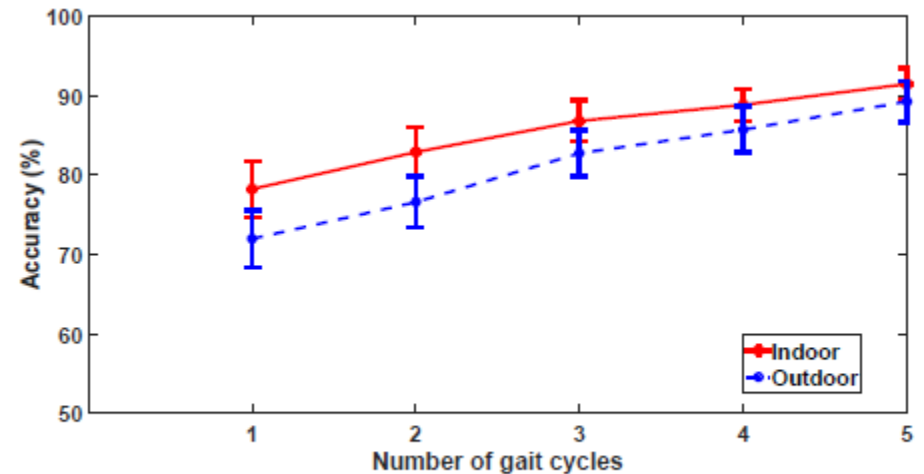

(d) EEH dataset

Our system achieves lower accuracy in outdoor environment, due to different road conditions.

Energy Consumption Analysis

- Measurement Setup

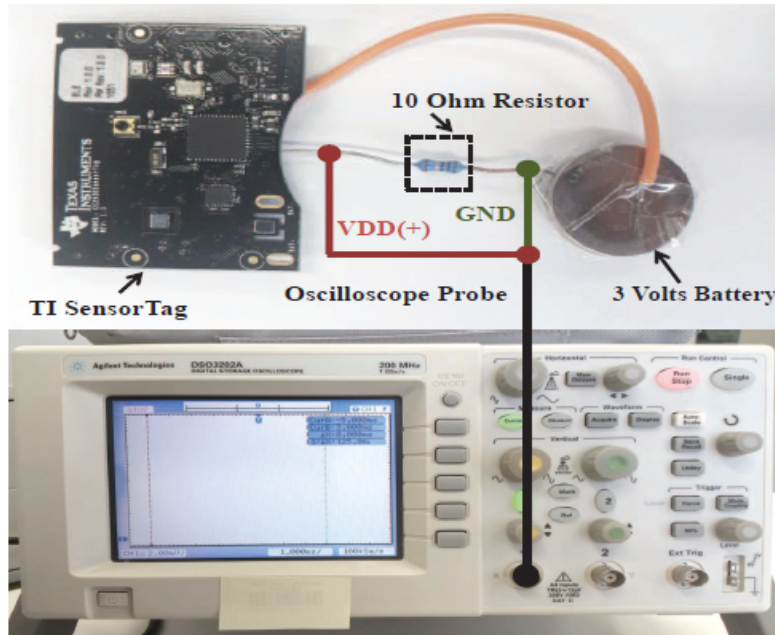

- Measurement Results

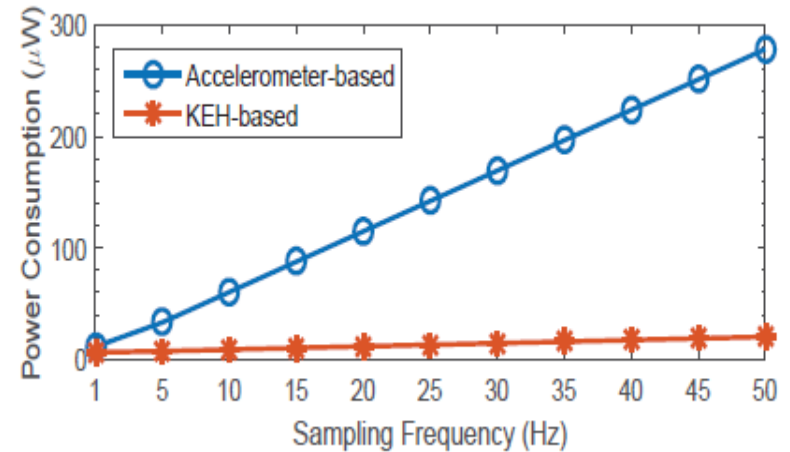

Our system can reduce energy consumption by 75.88%. (extend battery lifetime by 4 times)

Conclusions

- A novel KEH-based gait recognition system which uses only the KEH voltage as the source signal to achieve user authentication.
- Two different KEH prototypes, one based on piezoelectric energy harvester (PEH) and the other on electromagnetic energy harvester (EEH).
- We demonstrate that KEH-Gait reduces the power consumption of conventional accelerometer-based system by 78%.

Thanks for your
attention.

Questions?

For further questions, feel free to contact:
w.xu3@uq.edu.au